

Welcome to the **simplicity**
of **sophisticated imaging**

CS 8100 Family



Meet the new **panoramic and cephalometric imaging family**

INTRODUCING THE CS 8100 FAMILY

Effortless high-quality digital results

Outstanding value for money

Sleek, ultra-compact and elegant

[WORKFLOW INTEGRATION]



SOPHISTICATED TECHNOLOGY MADE THOUGHTFULLY SIMPLE

At Carestream Dental, we're redefining panoramic and cephalometric imaging and making a league of our own. The CS 8100 family combines the most advanced, sophisticated imaging technology in an extremely compact and simple system. In fact, it's the intelligence and sophistication that gives you the added simplicity. Like all Carestream Dental products, the CS 8100 family is built on three essential cornerstones: **workflow integration, humanized technology and diagnostic excellence.**

CS 8100 THE SIMPLICITY OF COMPACT PANORAMIC IMAGING

Giving you the best value for money without the added complexity of unnecessary programs or gadgets, the CS 8100 makes positioning easier, image acquisition faster and higher image quality more accessible. Essentially it's exactly what you need to streamline your workflow, improve your usability and make a more accurate real-time diagnosis.

Now the CS 8100 can be upgraded to 3D to meet your future imaging needs (not available on units with cephalometric option).

Perfect for everyday panoramic
and cephalometric needs

"Plug-and-pan" solution –
Easy to install, learn and use

[HUMANIZED TECHNOLOGY]

[DIAGNOSTIC EXCELLENCE]

CS 8100 RAPID HIGH-QUALITY CEPHALOMETRIC IMAGES

In addition to high-quality panoramic imaging, the CS 8100SC incorporates the world's fastest cephalometric imaging and tracing unit. With a full range of image formats, the CS 8100SC enables a wider range of diagnoses to be performed straight away, making it an ideal choice for everyday orthodontic and oral surgical needs.

AWARD-WINNING DESIGN



red*dot*

The compactness and user-friendliness of the CS 8100 has already been awarded eight international prizes, including the much coveted Red Dot Award product design 2013. The Red Dot jury appreciated, in particular, its compact footprint and slim design that enables it to be placed in almost any practice.



[Workflow integration]

Our systems and software are designed to fit seamlessly into your practice and improve your processes.

A REAL-TIME DIAGNOSIS IN JUST A FEW SIMPLE STEPS

QUICK AND EASY OPERATION

Waiting for film to develop is now a thing of the past. The advanced digital technology of the CS 8100 family allows you to spend less time waiting for images and performing routine tasks and more time providing patient care.

The intuitive user interface and computer-controlled system make selecting settings and entering patient information easy, with pre-set programs and exposure settings to minimize set-up time and errors. And positioning is simpler than it has ever been.

Clear instructions help you position the patient correctly and transparent patient support helps hold the patient comfortably in place.

A quick acquisition time of just 10 seconds for images, and as low as 3 seconds for cephalometric images, minimizes the risk of patient movement and the need for retakes. Almost immediately, a perfectly sharp, high-quality image will be ready for your review using our dental imaging software. A few simple steps are all it takes for a real-time diagnosis.

1. SELECT THE PROGRAM:



Simply select the program, enter the patient information, and if necessary, adjust the exposure settings.

2. POSITION THE PATIENT:



Face-to-face positioning, clear user instructions and innovative head support make patient positioning easy with no need for laser beams.

3. TAKE THE X-RAY:

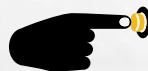

With just the touch of a button, the acquisition starts and the image is sent directly to your computer.

4. REVIEW THE IMAGE



Sharp, high-quality images with a range of filters lead to a more accurate diagnosis and treatment.

5. GET THE TRACING:

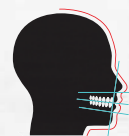

Exclusive software recognizes anatomical structures and landmarks and traces them automatically.*

* Only available with cephalometric option.

LITERALLY FITS ANY PRACTICE



EASILY INTEGRATED AND COMPACT

The simple workflow of the CS 8100 family aligns seamlessly with the current processes of your practice. The system connects via Ethernet directly to your network, and our imaging software can be used as a standalone program or integrated with your existing practice management program.

Furthermore, the ultra compact size of both the CS 8100 and the CS 8100SC means it can easily fit into tight spaces offering

versatile installation possibilities for your practice. For example, the CS 8100SC is one of the smallest cephalometric units available, measuring just 1.8 meter in width.

Both pieces of equipment are delivered in smart packaging for fast and easy installation that can be performed by just one person.



[Humanized **technology**]

We keep our technology simple for you and your patients, always enhancing ease of use and communication.

A PERFECT FIT FOR EVERY PATIENT...



EASILY ADJUSTABLE FOR PATIENTS OF ALL SIZES

Fully wheelchair accessible, the CS 8100 family can be easily adjusted for patients of all ages, standing or sitting. The machine's motorized silent movements provide precise and effortless height adjustments while putting your patients more at ease.

With the CS 8100 family, your patients will appreciate the convenience of a faster, more comfortable exam. And the exam will be safer for them as well, requiring a lower dose compared to traditional panoramic and cephalometric systems.



Stable, open positioning and fast scan times reduce the risk of motion artifact and improves patient comfort.

...AND EVERY STAFF MEMBER



An open design

Face-to-face positioning and transparent patient support with integrated handgrips facilitate proper patient positioning and help your patients feel secure and reduce feelings of claustrophobia or confinement.

The focal trough has an increased thickness in the anterior region, making it easier to place teeth in the sharpness area.

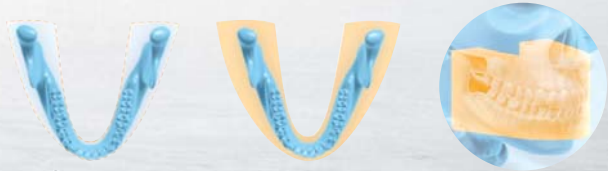

THE RIGHT POSITIONING FOR SUCCESSFUL IMAGES

Combined with enhanced patient comfort, the CS 8100 family offers increased positioning usability for dentists and dental assistants alike.

Simple step-by-step instructions on the modern user interface guide you through the process and minimize errors. Compared to traditional panoramic units, the increased thickness and width of the focal trough eliminates the need for laser beams for the midsagittal and Frankfort planes and provide greater tolerance

to imperfect positioning and challenging anatomy, especially in the anterior area. The enhanced focal trough together with an optimized positioning system, ultimately improves positioning, reduces the risk of retakes and streamlines your workflow even further.

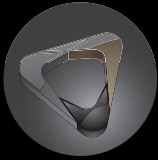

[Diagnostic excellence]

We help you do more than just identify a problem; we show you exactly where to take action.

EXCELLENT IMAGE QUALITY FOR EXCELLENT DIAGNOSTICS



SHARP, HIGH-QUALITY, ARTIFACT-FREE IMAGES

The CS 8100 family is designed to be small yet powerful. Featuring the very latest software processing algorithms, it minimizes spinal column shadows and produces clear and sharp digital images, ready almost immediately for your review.

When combined with the innovative horizontal design of the high-frequency X-ray DC generator (60-90 kV), it ensures that radiation remains constant throughout the exposure for optimal contrast. And an advanced Active Pixel CMOS sensor, vibration-free motion system and 0-5 mm focal spot ensure smooth capture of highly detailed and contrasted, crystal clear images in just seconds.

CS ADAPT MODULE SOFTWARE THAT MAKES A CLEAR DIFFERENCE

With the pioneering CS Adapt module you can get impressive image quality and clarity and even customize the look and feel of your images. One click lets you enhance image contrast and sharpness using our artifact-free filters. This filter prevents the creation of dark halos that are often mistaken for caries, lesions or bone loss around radio opaque areas.



SEE WHAT'S NOT ALWAYS EASILY SEEN

A COMPLETE RANGE OF PROGRAMS FOR EVERY NEED

In addition to four patient morphologies and three jaw shapes, the CS 8100 family gives you the image you want using a complete range of sophisticated acquisition programs. These versatile programs cover all your everyday panoramic exam needs, so that you can get the image you require for a proper analysis and recommendation of treatment. Whether you choose the affordable CS 8100 compact panoramic unit or the CS 8100SC cephalometric system, you will have everything you need for a successful diagnosis.



Standard panoramic – the most common program



Pediatric panoramic reduces the irradiation level



Lateral TMJ 4 views, mouth open and closed on the same image

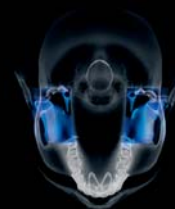

Panoramic without TMJ limits the exposure area for follow-up exams



Lateral TMJ 2 views, mouth open or closed

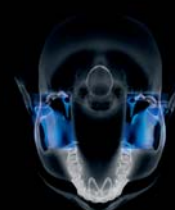

Segmented panoramic limits patient exposure to the area of interest

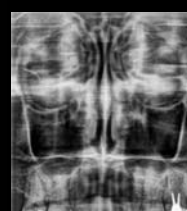

Sinus program for a clear view of maxillary sinuses



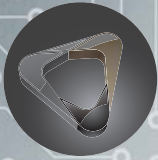

[Diagnostic **excellence**]

We help you do more than just identify a problem;
we show you exactly where to take action.

SEE MORE WITH OUR INNOVATIVE PROGRAMS

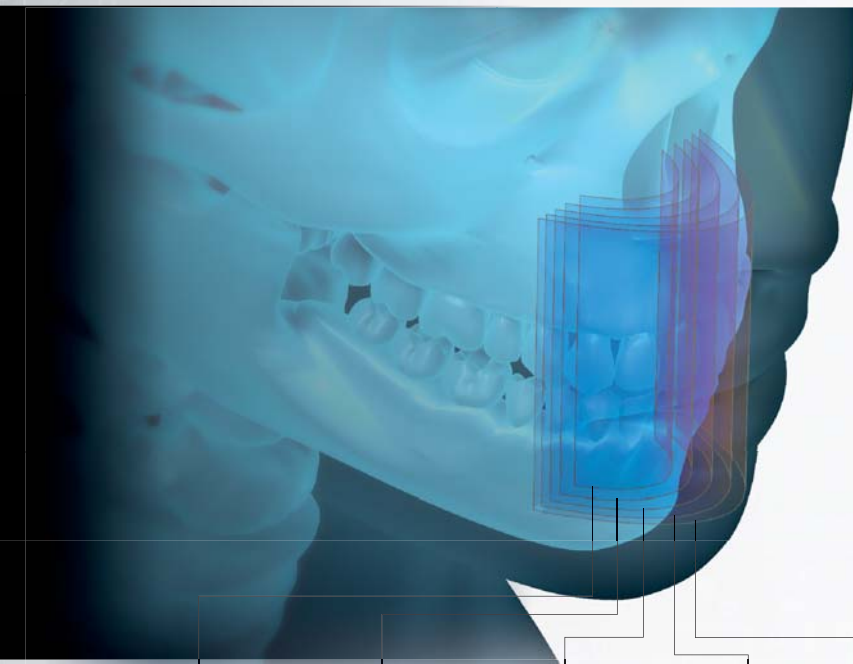

SEGMENTED BITEWING*

- Captures bitewing images in the same way as for caries detection
- Acquires two segments of the arch in one exposure
- Uses a specific trajectory to reduce teeth overlap

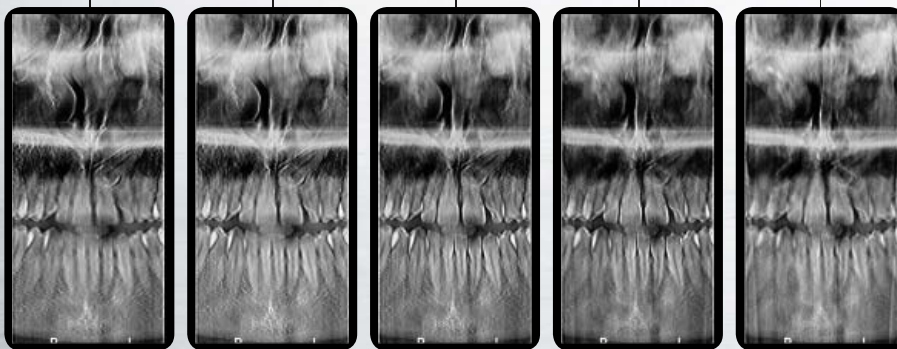

BETTER DIAGNOSES WITH EXCLUSIVE 2D+ PROGRAM

Our exclusive 2D+ program creates results that enable you to see more than what a standard 2D image provides. It focuses on just one area of interest, creating thin slices at regular intervals along the jaw.

This way of scoping the jaw allows for buccal/lingual exploration. In doing so, it helps you to better determine the location of supernumerary teeth, find impactions and apical lesions, or identify the root relationship to the inferior canal nerve.

* Results obtained with segmented bitewing program cannot be equivalent to a true intraoral bitewing examination

CS 8100SC

YOUR PATIENTS MOVE FAST, SO WE SCAN FASTER



3 SECONDS IS ALL IT TAKES TO ACQUIRE HIGH-QUALITY CEPHALOMETRIC IMAGES

- **Scanning in record time** – fastest ceph scanning in the world*
- **Exclusive automatic tracing software** – full tracing within 90 seconds**
- **CS Adapt module** – for impressive image clarity and customizable look and feel

*18 x 24 cm image in quick mode

**18 x 24 cm image

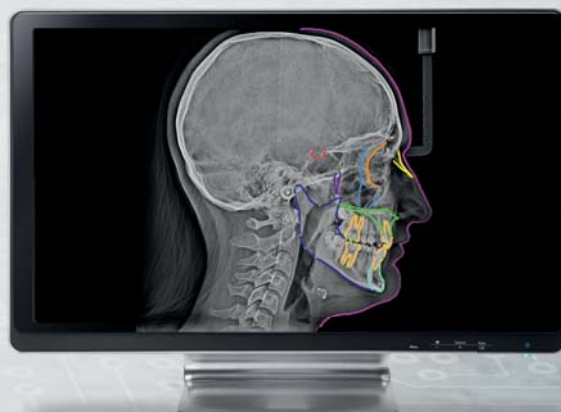

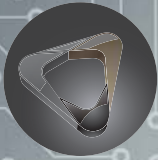

[Diagnostic excellence]

We help you do more than just identify a problem; we show you exactly where to take action.

OUTSTANDING IMAGES AT RECORD-BREAKING SPEED

The CS 8100SC is able to scan an 18 x 24 cm image in as little as three seconds using the quick mode. This makes it the fastest scanning cephalometric system in the world. Not only does this exceptional speed reduce the risk of motion blur, it also reduces exposure time for the patient. In other words, sharper exams and safer patient conditions.

TWO SCANNING MODES TO ADAPT TO YOUR DIAGNOSTIC NEEDS:

- High resolution mode for the highest quality images
- Quick mode with fast exposure – ideal for young patients and follow-up exams



CRANIAL FORMAT



26 X 24 CM

For cranial exams*



STANDARD FORMAT



18 X 24 CM

For standard exams



REDUCED FORMAT



18 X 18 CM

To limit exposure area

LATERAL VIEW



FRONTAL VIEWS (AP/PA)



CARPUS



A FULL RANGE OF PROGRAMS FOR ORTHODONTIC AND ORAL SURGERY

From a cranial option to the low dose format, the CS 8100SC provides a wide range of fields of view and image types to meet all your daily needs. Whatever the examination you choose, you can be sure of consistent high quality and clarity. And by selecting the image field you can limit the exposure area for better patient protection. You can choose between five different views: Lateral, Frontal, Oblique, Submento-vertex, and Carpus.

* Option available



ORTHODONTIC FILTERS THAT MEET YOUR SPECIFIC NEEDS

The CS 8100SC incorporates the pioneering CS Adapt software module. This state-of-the-art image processing software lets you choose and customize the look and feel of the images so they meet your exact preferences. The orthodontic pre-set filters help you visualize hard and soft tissue and let you choose between different image look and feel options – to create images of the highest quality and clarity.



Optimized contrast for a primary image analysis



For a better visualization of bone and cartilage

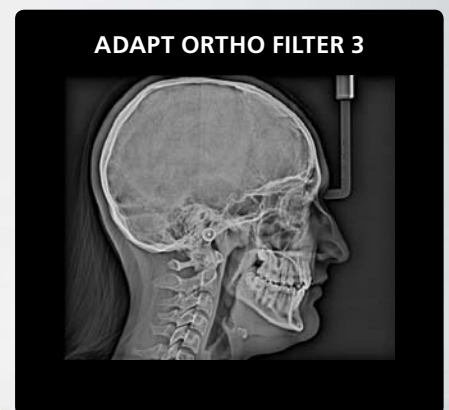

Enhanced edges for faster tracing

TWO SENSORS ARE BETTER THAN ONE

As a standard feature, the CS 8100SC comes with two sensors – one for each modality. This removes the need to change sensors between examinations, which reduces the risk of damage to the sensors. In addition, the two sensors eliminate the risk of manipulations.



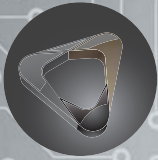

[Diagnostic **excellence**]

We help you do more than just identify a problem;
we show you exactly where to take action.

JUST 90 SECONDS FOR A FULL CEPHALOMETRIC TRACING

EXCLUSIVE AUTOMATIC TRACING SOFTWARE

Forget about spending up to ten minutes turning an exam into a tracing. With the CS 8100SC, your images are turned into tracings in just 90 seconds. The exclusive software automatically recognizes and traces anatomical structures – saving you and your team valuable time and giving you faster results.

The software covers the most common analysis needs, such as Ricketts, McNamara, Steiner and Tweed. And you can save even more time by using the editor function to personalize your tracings and create your own templates.



INTUITIVE SOFTWARE AND EASY SHARING



VIA EMAIL



CD/DVD



USB FLASH DRIVE



LIGHTWEIGHT
SCREEN CAPTURES



PRINT



USER-FRIENDLY TOOLS AND ENHANCED COMMUNICATION

Our intuitive dental imaging software, whether used as a standalone program or integrated with your practice management program, serves as the control panel for all Carestream Dental systems. It helps you analyze images quickly using powerful, user-friendly image processing tools. All features are accessible in just a few clicks to ensure that you get the high image quality you need for an accurate diagnosis.

Our comprehensive image software also greatly improves image sharing and communication. First, all dentists, staff practitioners or staff members inside the practice can access images on any networked PC. And second, images can be easily sent via email, saved to a USB or printed to make it simple to share images with patients or for referrals or insurance enquiries.

SUPPORT YOU CAN COUNT ON

The simplicity of the CS 8100 family ensures that installation and use are as easy and intuitive as possible. And it is backed by Carestream Dental's expert services and support. Our registered dealers and service providers are certified in quality installation and support, and many services can even be performed remotely, including: configuration, diagnosis, repair, calibration and software updates. This helps keep your service costs and downtime at a minimum – and your practice productivity at the absolute maximum.

CS 8100 FAMILY TECHNICAL SPECIFICATIONS

X-RAY GENERATOR	
Tube voltage	60 - 90 kV
Tube current	2 - 15 mA
Frequency	140 kHz
Tube focal spot	0.5 mm (IEC 60336)
Total filtration	> 2.5 mm eq. Al
Input voltage (AC)	100 - 240 V - 50/60 Hz
PANORAMIC MODALITY	
Sensor technology	CMOS
Image field	6.4 x 131.2 mm 6.4 x 120 mm (pediatric)*
Gray scale	4096 - 12 bits
Magnification	1.2 (± 10%)
Radiological exam	Full panoramic, segmented panoramic, maxillary sinus, LA TMJx 2, LA TMJx 4, 2D+
Exposure mode	4 patient sizes (Child, Adult: small, medium, large) 3 dental arch morphology (normal, square, sharp)
Exposure time	2 to 12.5 seconds
CEPHALOMETRIC MODALITY	
Sensor technology	CMOS
Image field	6.4 x 263.3 mm
Gray scale	16384 - 14 bits
Magnification	1.13 (± 10%)
Radiological exams	Lateral, frontal AP or PA, oblique, submento-vertex, carpus (optional)
Exposure time	3 to 10 seconds
Minimum required space	Without ceph arm: 1200 (L) x 1400 (D) x 2400 (H) mm With ceph arm: 2000 (L) x 1400 (D) x 2400 (H) mm
Weight	Without ceph arm: 72 kg (158 lb.) With ceph arm: 107 kg (236 lb.)

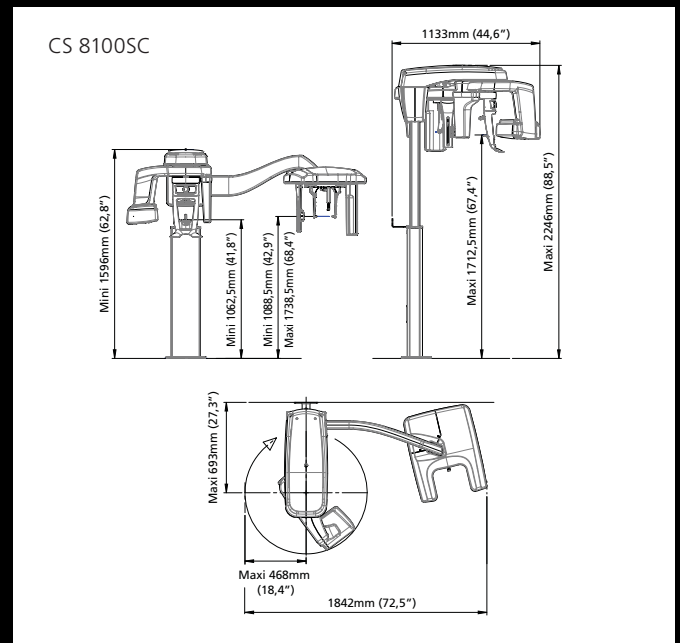
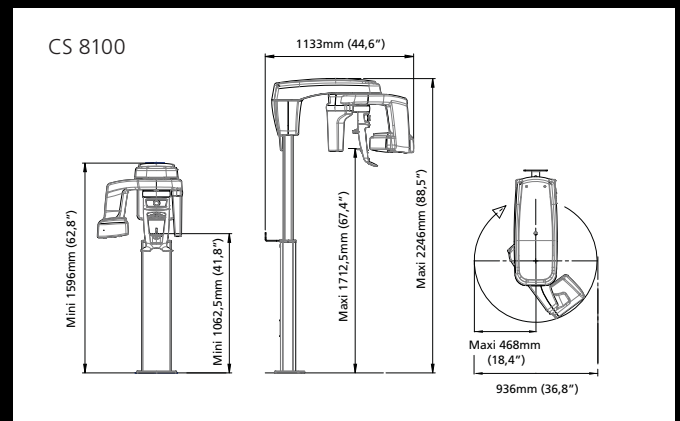

* Not available on CS 8100

LET'S REDEFINE EXPERTISE

The CS 8100 family is just one way we redefine imaging.

Discover more at carestreamdental.com or contact your local authorized dealer.